

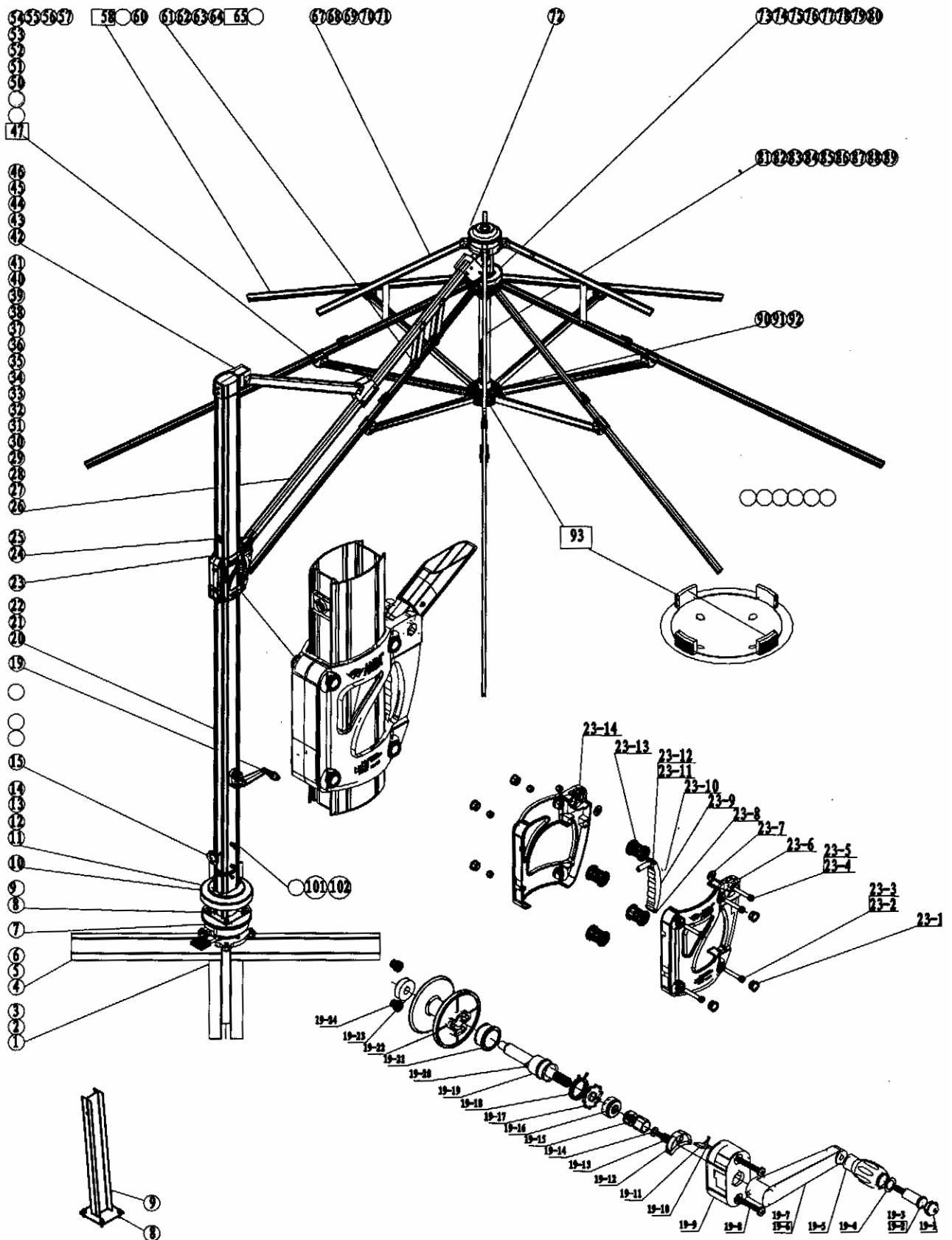

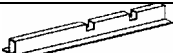













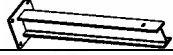



























Diagrams & Parts list





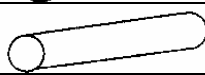









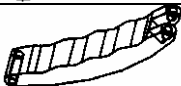



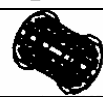



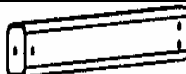





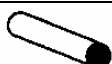





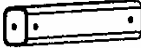

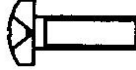









Parts List







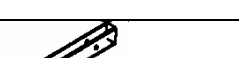

















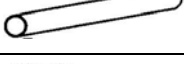

All nuts & bolts are in Metric system













Item No	Parts Name	Diagram	Qty (Pcs)
P-01	Lower cross base		1
P-02	Cross base end cap		4
P-03	Cross Base Insert		1
P-04	Upper cross base		1
P-05	Alan Head bolt – M8*30		4
P-06	Washer		9
P-07	Rotating Base		1
P-08	Alan Head bolt – M8*20		4
P-09	H style support base		1
P-10	Base cover		1
P-11	Main pole Supportive tube		1
P-12	Stainless steel bolt M6*25		2
P-13	Riveting nut M6*dia.9		2
P-14	Gasket		1
P-15	Thumbscrew knob		2
P-19-1	Crank handle cap		1
P-19-2	Alan head bolt—M6*35		1
P-19-3	Columnar sleeve		1
P-19-4	Washer		1
P-19-5	Crank handle		1
P-19-6	Crank arm		1
P-19-7	Built-in baffle spring		1
P-19-8	Stainless steel bolt-M5*35		2

P-19-9	Crank housing cover		1
P-19-10	Pawl		1
P-19-11	Pawl spring		1
P-19-12	Pawl baffle		1
P-19-13	Alan head bolt-M5*10		1
P-19-14	Washer		1
P-19-15	Crank axle		1
P-19-16	Bearing 51100		1
P-19-17	Sprocket wheel		1
P-19-18	Spring		1
P-19-19	Main axle		1
P-19-20	Round pin		1
P-19-21	Axle sleeve A		1
P-19-22	Rope wheel		1
P-19-23	Axle sleeve B		1
P-19-24	Nut M5*dia.7		4
P-20	Main pole		1
P-21	Tubular nut dia.6*58		1
P-22	Pulley		5
P-23-1	Décor cap for smooth runner housing		8
P-23-2	Alan head bolt M6*52		4
P-23-3	Lock nut M6		4

P-23-4	Alan head bolt M8*40		1
P-23-5	Lock nut M8		1
P-23-6	Smooth runner (right)		1
P-23-7	Plastic washer		1
P-23-8	Trigger axle		2
P-23-9	Trigger		1
P-23-10	Spring		1
P-23-11	Elastic Pin		1
P-23-12	Rivet dia.2.9*17		1
P-23-13	Wheel		1
P-23-14	Smooth runner(left)		4
P-24	Positioning piece		1
P-25	Stainless steel screw dia.4*12		1
P-26	Lower support arm 61"		1
P-27	Lower support arm connector		1
P-28	Stainless steel bolt-M5*30		1
P-29	Clamp		1
P-30	Washer for clamp		1
P-31	Stainless steel bolt-M5*40		6
P-32	Lock nut M5		7
P-33	Tubular nut (dia.6*24.8)		1
P-34	Stainless steel bolt M4*8		4
P-35	Lock washer – dia.6		6

P-36	Lower support arm connector bracket		1
P-37	Tubular nut - M6*33.9		1
P-38	Upper support arm 32.28"		1
P-39	Plastic cap		1
P-40	Stainless Steel bolt – M6*42		2
P-41	Lock nut M6		2
P-42	Top holder		1
P-43	Cover piece		1
P-44	Stainless steel screw dia.2.9*9.5		2
P-45	Alan Head bolt – M5*16		2
P-46	Block piece to prevent rope moving out of pulley		1
P-47	Long rib - 81"		4
P-50	Protective washer		8
P-51	Return arm A 27"		4
P-52	Rib End cap		32
P-53	Rib connector		8
P-54	Stainless Steel screw (M4x12)		27
P-55	Stainless Steel bolt – M5*25		16
P-56	Lock nut M5		20
P-57	Fabric hook		8
P-58	Short rib - 58"(1.0mm thickness)		3
P-60	Return arm B 26"		4
P-61	Vent top support arm		8
P-62	Sleeve for rib		1
P-63	Washer for rib sleeve		4

P-64	Flat Washer		22
P-65	Short rib - 58"(1.5mm thickness)		1
P-67	Vent top Rib End cap		8
P-68	Vent top rib 31"		4
P-69	Stainless steel bolt M4*28		4
P-70	Lock nut M4		4
P-71	Vent top hub		1
P-72	Vent top cap		1
P-73	Electric box cover		1
P-74	Stainless Steel screw (dia4x30)		2
P-75	Half Hub w/Electric box		1
P-76	Stainless steel screw dia.2.2*9.5		2
P-77	Hub(lower half)		1
P-78	Rib pin		16
P-79	Stainless steel bolt M5*35		4
P-80	Lock nut M5		8
P-81	Center pole - 21.6"		1
P-82	Rope guide insert		1
P-83	Positioning clip		1
P-84	Tubular nut - M6*49.5		1
P-85	Pulley		1
P-86	Rivet		6
P-87	Stainless steel bolt M8*45		1
P-88	Lock nut M8		1
P-89	Washer		1
P-90	Hub(lower half)		1

P-91	Hub(upper half)		2
P-92	Stainless steel bolt M5*30		4
P-93	Décor cap for hub		1
P-101	Stainless steel screw M8*30 for pillar pole		4
P-102	Nut(M8*dia.11*18)		4
P-103	Blocking piece to separate rope from wires		
P-104	Décor cap for M5 Nut		14
P-105	Décor cap for M6 Nut		1
P-106	Décor cap for M8 Nut		2
P-107	Nylon rope		1
P-108	Main canopy		1
P-109	Top Vent Cover		1

Warranty

Warranty Coverage and Term of Period:

Wanda Technology, Inc. warrants that this umbrella, when subject to normal and proper use, will be free from manufacturing defects for a period of one year from the date of purchase. Should any defect occur during the specified time period, *Wanda Technology, Inc.* will repair the defect product or provide replacement parts and components material, at its own option. *Wanda Technology, Inc.* also reserves the right to issue a full refund of the purchase price in lieu of repair or replacement.

Transferability: This warranty is not transferable.

Other Conditions:

This warranty replaces all other oral or written warranties, liabilities or obligations of *Summer Accents, Inc.* Pertinent state law shall control for what period of time following the purchase a consumer may seek a remedy under the implied warranty of merchantability or fitness for a particular purpose. In no event shall *Wanda Technology, Inc.* be liable for consequential or incidental damages of any kind resulting from the breach of this warranty. Some states do not allow limitations on, or the exclusion of, incidental or consequential damages, so the above exclusions may not apply to you.

For Help or Warranty Service Contact:

Wanda Technology Inc.

Customer Service Center

www.WandaTech.com