



Wanda Technology Inc.

Side Post Aluminum Umbrella

Portofino pro II Series

OWNER'S MANUAL

US Patents: 6,439,249 ; 6,692,135 ; 6,598,990 ; 6,966,667
6,945,263 ; 6,923,194 ; 6,830,058 ; 6,565,060
6,511,033 ; 6,637,717 ; 6,488,254 ; 6,585,219

Other Patents and/or Patent Pending are available upon request.

For Help or Warranty Service Contact:

Wanda Technology Inc.

www.WandaTech.com

Oct. 2007

WARNING!!

Never Leave this product in the open position over night or while away. Weather conditions causing gusting winds could result in damage to this product. If you notice excessive swaying or movement in windy conditions, close the shade system.

Under no circumstances is Wanda Technology Inc. responsible for any damage caused by the shade system resulting from, but not limited to, any weather related causes.

******Before using your umbrella, you must do the following******

1. Bolt the base to your existing patio structure.
(OR)
2. Have Four (4) 18-inch Patio Stones, or similar, weighing approximately 35 lbs each. It may be necessary to add additional stones or planters to meet the minimum weight requirement. The total weight should be at least 140lbs. Place one patio stone on all four sides of the umbrella's "base cross legs". This will give the umbrella the support needed. If needed you can add planters on top of the patio stones to give additional weight.

SPECIAL REMINDER

When cranking the umbrella open, if you feel resistance and the umbrella is not opening, do NOT force the crank. Simply, spread open the ribs using your hands then continue to crank open the umbrella.

LIMITED WARRANTY

Wanda Technology Inc. will replace and or repair any defective parts & components within a period of (1) year from the delivery date. This warranty does not include abuse, misuse, vandalism, negligence improper installation, accidents casualty, normal wear and tear, or other causes for other repair not defined by Wanda Technology Inc. as a defect. The limited warranty only applies to the dealers, and is not assignable. All warranties are void without receipt.

Any question, please visit our website at www.WandaTech.com or contact our service center at 714-549-4448

ASSEMBLY INSTRUCTIONS

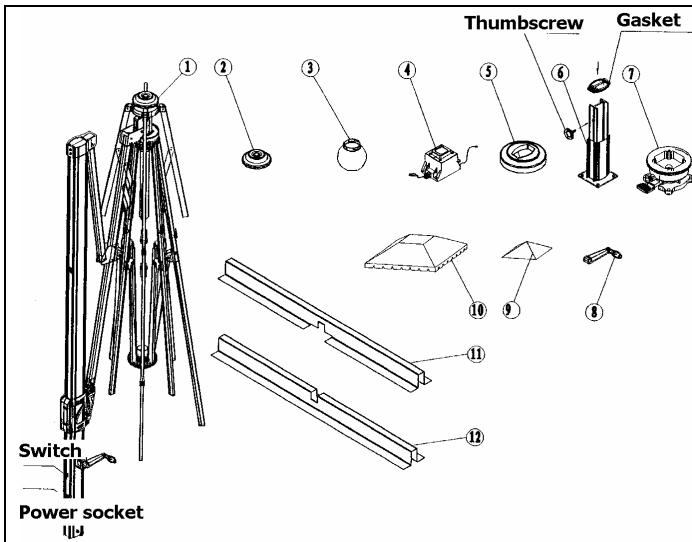

1

STEP 1.

Inspect umbrella frame and all component parts before assembly.

1. Frame
2. Vent top cap
3. Light cover and light bulb
4. Transformer
5. Plastic cover
6. H-style Support base with thumbscrew and gasket(M5, M6 wrenches included)
7. Rotating Base (bolts, washers and M8 wrench included)
8. Crank handle
9. Vent top cover
10. Main fabric
11. Upper cross base
12. Lower cross base

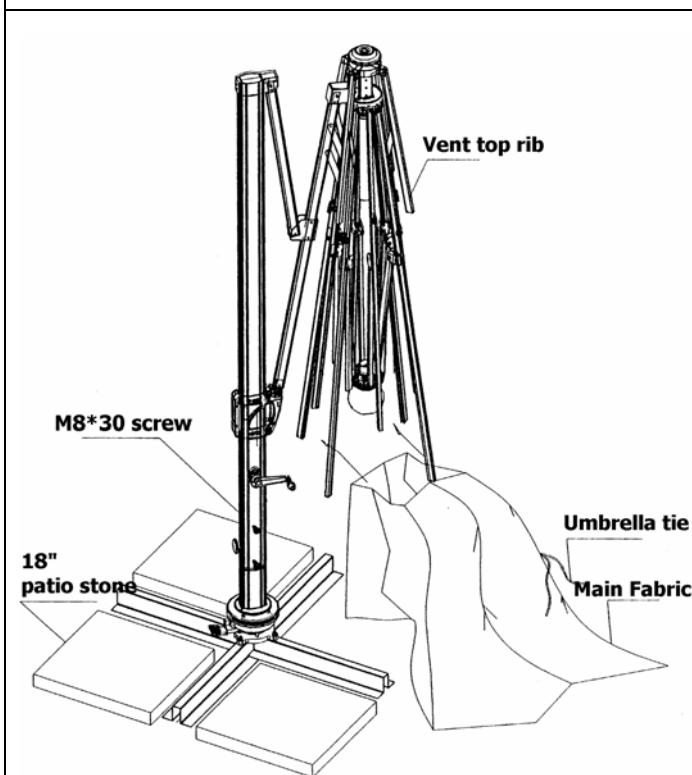

2

STEP 2

* Cross the two bottom base legs (11-12). Then mount the rotating base (7) to the top of the cross legs with four M8X30 Alan head bolts.

* Attach the H-style support base (6) to the rotating base with four M8x20 bolts, remove the thumbscrew and gasket, then slide the plastic cover over the support base and restore the gasket.

* Insert the main Frame (1) onto the H-style support base, tighten the four M8x30 screws on the bottom of the pole and secure the thumbscrew.

NOTE: you MUST secure the base by one of the following: (Two options)

- 1) Bolt the base cross legs to your Existing Patio OR
- 2) Place one 18" patio stone on all four sides of the Base Cross Legs (See Diagram 2). Option "2" will allow your umbrella to be portable. (Patio stones are not included)

TOP COVER INSTALLATION

* Place the vent top fabric over the vent ribs and insert the ribs into the four pockets. Now, screw down the Vent top plastic cap. (See Diagram 2)

* Open the main fabric and from the bottom slide the main fabric over the ribs. Attach the fabric to the Rib hooks located at the top of each rib. Please note the Umbrella ties must be positioned on the Short rib in front of umbrella (See Diagram 2).

* Turn the crank clockwise to open the umbrella about half way. Now, one at a time, release the fabric from one upper rib hook and insert the rib into the bottom pocket of Main fabric, then reattach onto the upper hook. Repeat until all eight ribs are completed. Then, open canopy all the way.

* Finally, insert the light bulb into the socket and then attach the light cover. (see diagram 2)

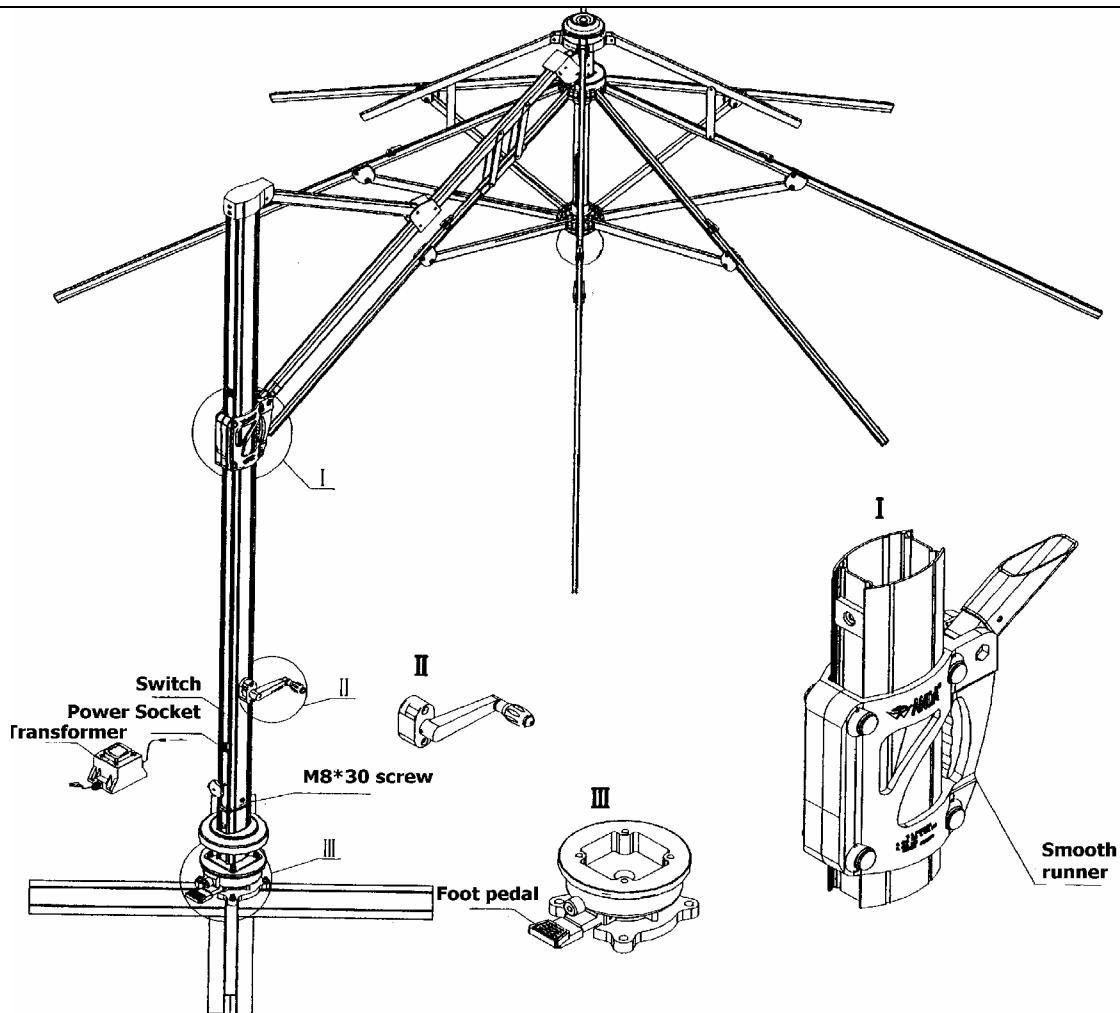

3

STEP 3.

* To open umbrella, turn the crank clockwise. To close umbrella, turn the crank counter clockwise. **IMPORTANT:** When cranking, if you feel resistance and the umbrella is not opening, spread the umbrella ribs using your hands, then continue to crank open.

* When you want to change the angle of your umbrella, squeeze the pistol grip and move it up or down to locate the preferred angle. (See I of Diagram3)

Operations for lighting system

* Plug the transformer box directly into a 120V or 220v power source and insert the cord end into the Power Socket, located on the main post.

* Push “----” the moonlight is dim and starlight’s are bright.

* Push “==” the moonlight is bright and the starlight’s are off.

* Push “o” and the power will turn off.











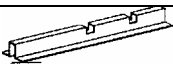







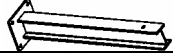



To store the umbrella, first squeeze the pistol grip and pull downward then rotate crank counter clockwise to close the umbrella. Use the ties to secure the main fabric to the post.























Step 4.







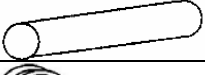











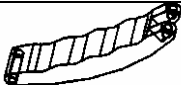



You can rotate your umbrella up to 360 degrees by simply stepping on the foot pedal and at the same time, move the umbrella using your hands to the preferred position. Once the umbrella has reached the new position, just release the foot pedal and the umbrella will automatically lock into place.















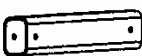









Parts List













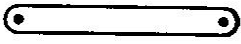











All nuts & bolts are in Metric system











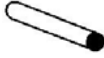
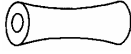









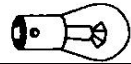

Item No	Parts Name	Diagram	Qty (Pcs)
P-01	Lower cross base		1
P-02	Cross base end cap		4
P-03	Cross Base Insert		1
P-04	Upper cross base		1
P-05	Alan Head bolt – M8*30		4
P-06	Washer		9
P-07	Rotating Base		1
P-08	Alan Head bolt – M8*20		4
P-09	H style support base		1
P-10	Base cover		1
P-11	Main pole Supportive tube		1
P-12	Stainless steel bolt M6*25		2
P-13	Riveting nut M6*dia.9		2
P-14	Gasket		1
P-15	Thumbscrew knob		2
P-16	AC power socket +-		1
P-17	Stainless steel screw-dia.2.9*9.5		2
P-18	Switch		1
P-19-1	Crank handle cap		1
P-19-2	Alan head bolt—M6*35		1
P-19-3	Columnar sleeve		1
P-19-4	Washer		1
P-19-5	Crank handle		1

P-19-6	Crank arm		1
P-19-7	Built-in baffle spring		1
P-19-8	Stainless steel bolt-M5*35		2
P-19-9	Crank housing cover		1
P-19-10	Pawl		1
P-19-11	Pawl spring		1
P-19-12	Pawl baffle		1
P-19-13	Alan head bolt-M5*10		1
P-19-14	Washer		1
P-19-15	Crank axle		1
P-19-16	Bearing 51100		1
P-19-17	Sprocket wheel		1
P-19-18	Spring		1
P-19-19	Main axle		1
P-19-20	Round pin		1
P-19-21	Axle sleeve A		1
P-19-22	Rope wheel		1
P-19-23	Axle sleeve B		1
P-19-24	Nut M5*dia.7		4
P-20	Main pole		1
P-21	Tubular nut dia.6*58		1
P-22	Pulley		5

P-23-1	Décor cap for smooth runner housing		8
P-23-2	Alan head bolt M6*52		4
P-23-3	Lock nut M6		4
P-23-4	Alan head bolt M8*40		1
P-23-5	Lock nut M8		1
P-23-6	Smooth runner (right)		1
P-23-7	Plastic washer		1
P-23-8	Trigger axle		2
P-23-9	Trigger		1
P-23-10	Spring		1
P-23-11	Elastic Pin		1
P-23-12	Rivet dia.2.9*17		1
P-23-13	Wheel		1
P-23-14	Smooth runner(left)		4
P-24	Positioning piece		1
P-25	Stainless steel screw dia.4*12		1
P-26	Lower support arm 61"		1
P-27	Lower support arm connector		1
P-28	Stainless steel bolt-M5*30		1
P-29	Clamp		1
P-30	Washer for clamp		1
P-31	Stainless steel bolt-M5*40		6
P-32	Luck nut M5		7

P-33	Tubular nut (dia.6*24.8)		1
P-34	Stainless steel bolt M4*8		4
P-35	Lock washer – dia.6		6
P-36	Lower support arm connector bracket		1
P-37	Tubular nut - M6*33.9		1
P-38	Upper support arm 32.28"		1
P-39	Plastic cap		1
P-40	Stainless Steel bolt – M6*42		2
P-41	Lock nut M6		2
P-42	Top holder		1
P-43	Cover piece		1
P-44	Stainless steel screw dia.2.9*9.5		2
P-45	Alan Head bolt – M5*16		2
P-46	Block piece to prevent rope moving out of pulley		1
P-47	Long rib - 81"		4
P-48	Long rope light 77.95"		4
P-49	Rib End cap		15
P-50	Protective washer		8
P-51	Return arm A 27"		4
P-52	Rib End cap		16
P-53	Rib connector		8
P-54	Stainless Steel screw (M4x12)		27
P-55	Stainless Steel bolt – M5*25		16
P-56	Lock nut M5		20
P-57	Fabric hook		8

P-58	Short rib - 58"(1.0mm thickness)		3
P-59	Short rope light 55.12"		3
P-60	Return arm B 26"		4
P-61	Vent top support arm		8
P-62	Sleeve for rib		1
P-63	Washer for rib sleeve		4
P-64	Flat Washer		22
P-65	Short rib - 58"(1.5mm thickness)		1
P-66	Short rope light 55.12" for the rib under lower support arm		1
P-67	Vent top Rib End cap		8
P-68	Vent top rib 31"		4
P-69	Stainless steel bolt M4*28		4
P-70	Lock nut M4		4
P-71	Vent top hub		1
P-72	Vent top cap		1
P-73	Electric box cover		1
P-74	Stainless Steel screw (dia4x30)		2
P-75	Electric box		1
P-76	Stainless steel screw dia.2.2*9.5		2
P-77	Hub(lower half)		1
P-78	Rib pin		16
P-79	Stainless steel bolt M5*35		4
P-80	Lock nut M5		8
P-81	Center pole - 21.6"		1
P-82	Rope guide insert		1
P-83	Positioning clip		1

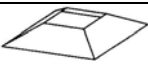
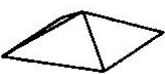
P-84	Tubular nut - M6*49.5		1
P-85	Pulley		1
P-86	Rivet		6
P-87	Stainless steel bolt M8*45		1
P-88	Lock nut M8		1
P-89	Washer		1
P-90	Hub(lower half)		1
P-91	Hub(upper half)		2
P-92	Stainless steel bolt M5*30		4
P-93	Light dome holder		1
P-94	Light bulb socket assembly		1
P-95	Stainless steel screw M3*10		1
P-96	Lock nut M3		1
P-97	Stainless steel screw dia.4*12		3
P-98	Light bulb		1
P-99	Light bulb dome		1
P-100	(110/12V) Transformer		1
P-101	Stainless steel screw M8*30 for pillar pole		4
P-102	Nut(M8*dia.11*18)		4
P-103	Blocking piece to separate rope from wires		
P-104	Décor cap for M5 Nut		14
P-105	Décor cap for M6 Nut		1
P-106	Décor cap for M8 Nut		2
P-107	Nylon rope		1
P-108	Main canopy		1
P-109	Top Vent Cover		1

Warranty

Warranty Coverage and Term of Period:

Wanda Technology, Inc. warrants that this umbrella, when subject to normal and proper use, will be free from manufacturing defects for a period of one year from the date of purchase. Should any defect occur during the specified time period, *Wanda Technology, Inc.* will repair the defect product or provide replacement parts and components material, at its own option. *Wanda Technology, Inc.* also reserves the right to issue a full refund of the purchase price in lieu of repair or replacement.

Transferability: This warranty is not transferable.

Other Conditions:

This warranty replaces all other oral or written warranties, liabilities or obligations of *Summer Accents, Inc.* Pertinent state law shall control for what period of time following the purchase a consumer may seek a remedy under the implied warranty of merchantability or fitness for a particular purpose. In no event shall *Wanda Technology, Inc.* be liable for consequential or incidental damages of any kind resulting from the breach of this warranty. Some states do not allow limitations on, or the exclusion of, incidental or consequential damages, so the above exclusions may not apply to you.

For Help or Warranty Service Contact:

Wanda Technology Inc.

Customer Service Center

www.WandaTech.com